

AEROLINE[®] CU SPLIT AEROLINE[®] CU PRO

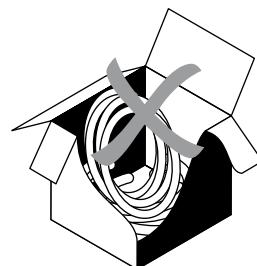

	
	2
	2
	3
	3 - 4
	4

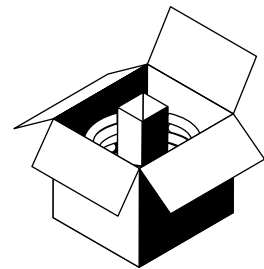

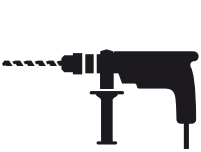
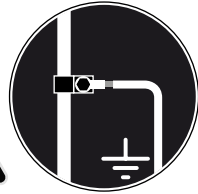
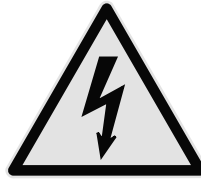
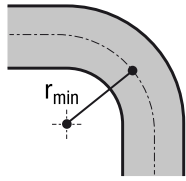

	mm	10	12	15	18
	mm	60	72	90	108

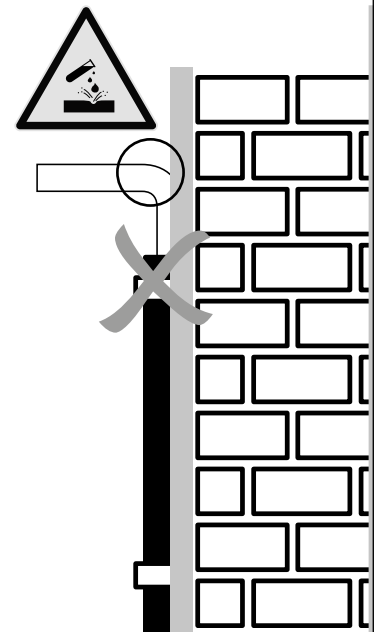
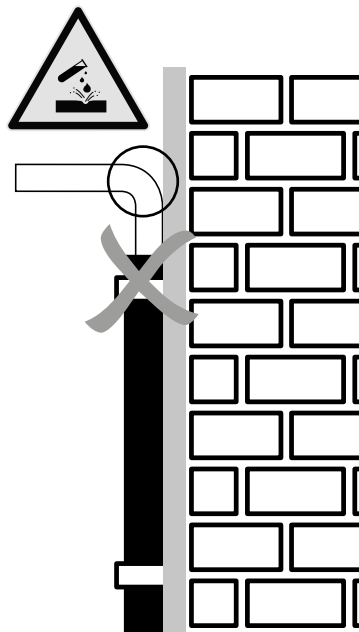
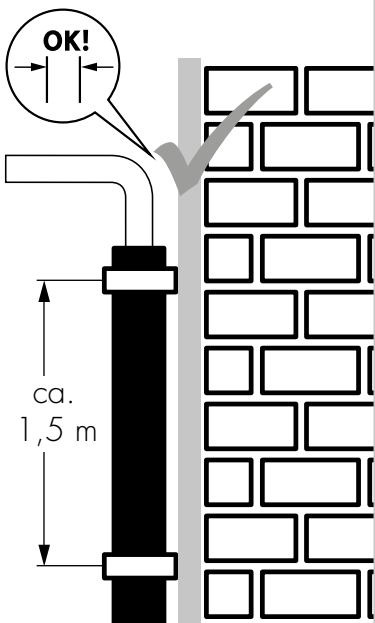
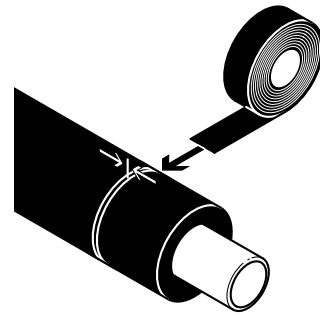
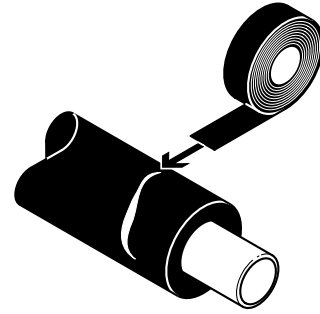
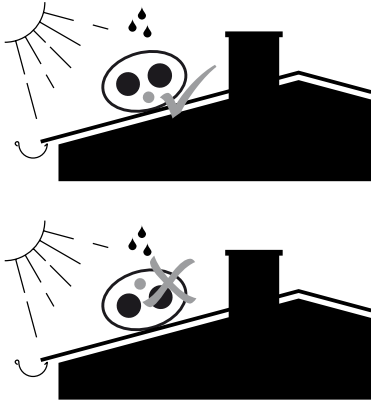
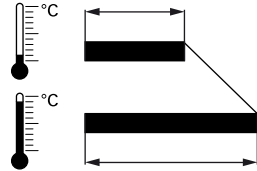
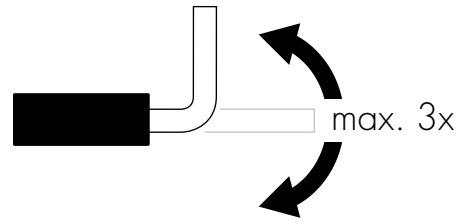

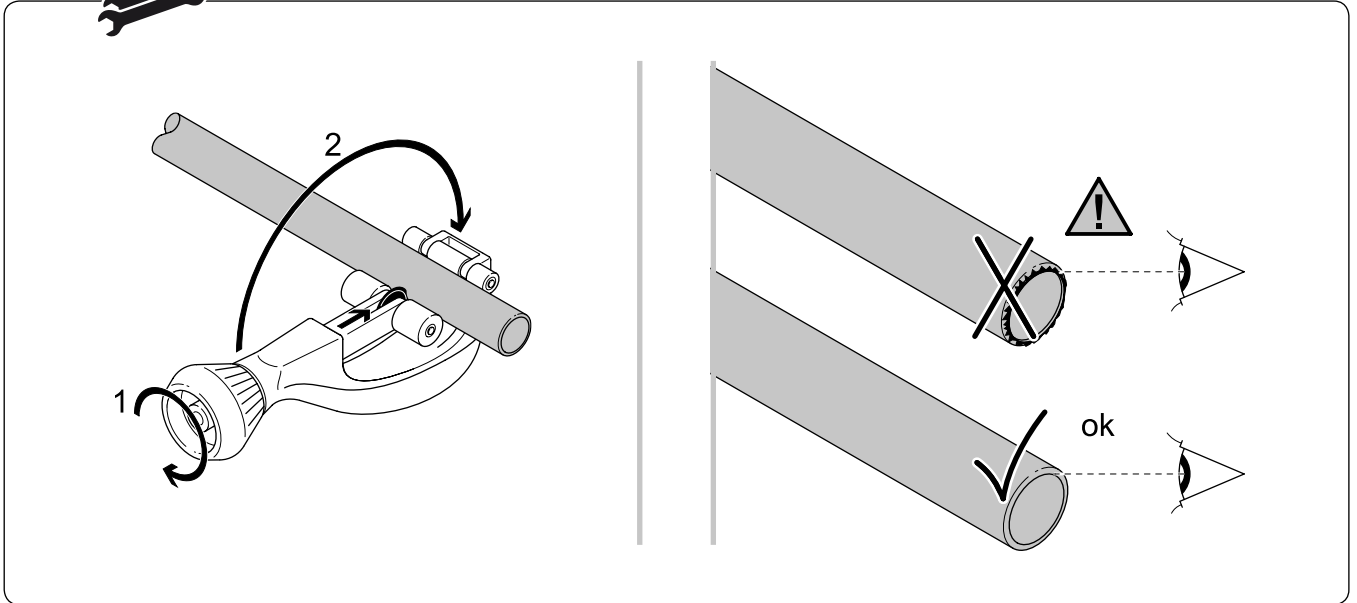

Normen und Vorschriften Norms and instructions

DIN VDE 0185 Teil 1-4	DIN 18 421
DIN 4708	DIN 1988, Teil 7
DIN 4753, Teil 1	DIN EN 12828
DIN 4757, Teil 1	EN 12976
DIN 18 380	EN 12977
DIN 18 381	

Landesspezifische Vorschriften beachten!
Country-specific regulations must be observed!



TECHNICAL
INSULATION

nmc Deutschland GmbH
Niederlassung Neu-Ulm
Pfaffenweg 34/1 - 89231 Neu-Ulm
Tel.: +49-731-93292 0
info-ulm@nmc-deutschland.de
nmc-insulation.com